

SPLIT-TYPE AIR CONDITIONERS

INDOOR UNIT

MSZ-FH06NA MSZ-FH09NA MSZ-FH12NA
MSZ-FH15NA MSZ-FH18NA MSZ-FH18NA2



OPERATING INSTRUCTIONS

For user

- To use this unit correctly and safely, be sure to read these operating instructions before use.

MANUAL DE INSTRUCCIONES

Para los clientes

- Para utilizar esta unidad de forma correcta y segura, lea previamente estas instrucciones de funcionamiento.

NOTICE D'UTILISATION

A l'attention des clients

- Pour avoir la certitude d'utiliser cet appareil correctement et en toute sécurité, veuillez lire cette notice d'instructions avant de mettre le climatiseur sous tension.

English

Español

Français



CONTENTS

■ SAFETY PRECAUTIONS	1
■ NAME OF EACH PART	3
■ PREPARATION BEFORE OPERATION	3
■ I-SEE OPERATION	5
■ SELECTING OPERATION MODES	6
■ FAN SPEED AND AIRFLOW DIRECTION ADJUSTMENT	7
■ SMART SET OPERATION	8
■ ECONO COOL OPERATION	8
■ NATURAL FLOW OPERATION	9
■ POWERFUL OPERATION	9
■ TIMER OPERATION (ON/OFF TIMER)	9
■ WEEKLY TIMER OPERATION	10
■ CLEANING	11
■ WHEN YOU THINK THAT TROUBLE HAS OCCURRED	12
■ WHEN THE AIR CONDITIONER IS NOT GOING TO BE USED FOR A LONG TIME	13
■ INSTALLATION PLACE AND ELECTRICAL WORK	13
■ SPECIFICATIONS	13







SAFETY PRECAUTIONS



- Since rotating parts and parts which could cause an electric shock are used in this product, be sure to read these "Safety Precautions" before use.
- Since the cautionary items shown here are important for safety, be sure to observe them.
- After reading this manual, keep it together with the installation manual in a handy place for easy reference.
- Be sure to receive a guarantee card from your dealer and check that the purchased date and shop name, etc. are entered correctly.









Marks and their meanings

-  **WARNING :** Incorrect handling could cause serious hazard, such as death, serious injury, etc. with a high probability.
-  **CAUTION :** Incorrect handling could cause serious hazard depending on the conditions.





Meanings of symbols used in this manual

-  : Be sure not to do.
-  : Be sure to follow the instruction.
-  : Never insert your finger or stick, etc.
-  : Never step onto the indoor/outdoor unit and do not put anything on them.
-  : Danger of electric shock. Be careful.
-  : Be sure to disconnect the power supply plug from the power outlet.
-  : Be sure to shut off the power.

 WARNING	
	<p>Do not connect the power cord to an intermediate point, use an extension cord, or connect multiple devices to a single AC outlet.</p> <ul style="list-style-type: none"> • This may cause overheating, fire, or electric shock.
	<p>Make sure the power plug is free of dirt and insert it securely into the outlet.</p> <ul style="list-style-type: none"> • A dirty plug may cause fire or electric shock.
	<p>Do not bundle, pull, damage, or modify the power cord, and do not apply heat or place heavy objects on it.</p> <ul style="list-style-type: none"> • This may cause fire or electric shock.
	<p>Do not turn the breaker OFF/ON or disconnect/connect the power plug during operation.</p> <ul style="list-style-type: none"> • This may create sparks, which can cause fire. • After the indoor unit is switched OFF with the remote controller, make sure to turn the breaker OFF or disconnect the power plug.
	<p>Do not expose your body directly to cool air for a prolonged length of time.</p> <ul style="list-style-type: none"> • This could be detrimental to your health.
	<p>The unit should not be installed, relocated, disassembled, altered, or repaired by the user.</p> <ul style="list-style-type: none"> • An improperly handled air conditioner may cause fire, electric shock, injury, or water leakage, etc. Consult your dealer. • If the power supply cord is damaged, it must be replaced by the manufacturer or its service agent in order to avoid a hazard.
	<p>When installing, relocating, or servicing the unit, make sure that no substance other than the specified refrigerant (R410A) enters the refrigerant circuit.</p> <ul style="list-style-type: none"> • Any presence of foreign substance such as air can cause abnormal pressure rise and may result in explosion or injury. • The use of any refrigerant other than that specified for the system will cause mechanical failure, system malfunction, or unit breakdown. In the worst case, this could lead to a serious impediment to securing product safety.





	<p>This appliance is not intended for use by persons (including children) with reduced physical, sensory or mental capabilities, or lack of experience and knowledge, unless they have been given supervision or instruction concerning use of the appliance by a person responsible for their safety.</p> <p>Children should be supervised to ensure that they do not play with the appliance.</p>
 	<p>Do not insert your finger, a stick, or other objects into the air inlet or outlet.</p> <ul style="list-style-type: none"> • This may cause injury, since the fan inside rotates at high speeds during operation.
 	<p>In case of an abnormal condition (such as a burning smell), stop the air conditioner and disconnect the power plug or turn the breaker OFF.</p> <ul style="list-style-type: none"> • A continued operation in the abnormal state may cause a malfunction, fire, or electric shock. In this case, consult your dealer.
	<p>When the air conditioner does not cool or heat, there is a possibility of refrigerant leakage. In this case, consult your dealer. If a repair involves recharging the unit with refrigerant, ask the service technician for details.</p> <ul style="list-style-type: none"> • The refrigerant used in the air conditioner is safe. Normally, it does not leak. However, if refrigerant leaks and comes in contact with a heat source such as a fan heater, kerosene heater, or cooking stove, it will create a harmful gas. <p>The user should never attempt to wash the inside of the indoor unit. Should the inside of the unit require cleaning, contact your dealer.</p> <ul style="list-style-type: none"> • Unsuitable detergent may cause damage to plastic material inside the unit, which may result in water leakage. Should detergent come in contact with electrical parts or the motor, it will result in a malfunction, smoke, or fire.
 CAUTION	
	<p>Do not touch the air inlet or the aluminum fins of the indoor/outdoor unit.</p> <ul style="list-style-type: none"> • This may cause injury.
	<p>Do not use insecticides or flammable sprays on the unit.</p> <ul style="list-style-type: none"> • This may cause a fire or deformation of the unit.

SAFETY PRECAUTIONS

 CAUTION		
	Do not expose pets or houseplants to direct airflow. • This may cause injury to the pets or plants.	
	Do not place other electric appliances or furniture under the indoor/outdoor unit. • Water may drip down from the unit, which may cause damage or malfunction.	
	Do not leave the unit on a damaged installation stand. • The unit may fall and cause injury.	
	Do not step on an unstable bench to operate or clean the unit. • This may cause injury if you fall down.	
	Do not pull the power cord. • This may cause a portion of the core wire to break, which may cause overheating or fire.	
	Do not charge or disassemble the batteries, and do not throw them into a fire. • This may cause the batteries to leak, or cause a fire or explosion.	
	Do not operate the unit for more than 4 hours at high humidity (80% RH or more) and/or with windows or outside door left open. • This may cause the water condensation in the air conditioner, which may drip down, wetting or damaging the furniture. • The water condensation in the air conditioner may contribute to growth of fungi, such as mold.	
	Do not use the unit for special purposes, such as storing food, raising animals, growing plants, or preserving precision devices or art objects. • This may cause deterioration of quality, or harm to animals and plants.	
	Do not expose combustion appliances to direct airflow. • This may cause incomplete combustion.	
	Never put batteries in your mouth for any reason to avoid accidental ingestion. • Battery ingestion may cause choking and/or poisoning.	
	Before cleaning the unit, switch it OFF and disconnect the power plug or turn the breaker OFF. • This may cause injury, since the fan inside rotates at high speeds during operation.	
	When the unit will be unused for a long time, disconnect the power plug or turn the breaker OFF. • The unit may accumulate dirt, which may cause overheating or fire.	
	Replace all batteries of the remote controller with new ones of the same type. • Using an old battery together with a new one may cause overheating, leakage, or explosion.	
	If the battery fluid comes in contact with your skin or clothes, wash them thoroughly with clean water. • If the battery fluid comes in contact with your eyes, wash them thoroughly with clean water and immediately seek medical attention.	
	Ensure that the area is well-ventilated when the unit is operated together with a combustion appliance. • Inadequate ventilation may cause oxygen starvation.	
	Turn the breaker OFF when you hear thunder and there is a possibility of a lightning strike. • The unit may be damaged if lightning strikes.	
	After the air conditioner is used for several seasons, perform inspection and maintenance in addition to normal cleaning. • Dirt or dust in the unit may create an unpleasant odor, contribute to growth of fungi, such as mold, or clog the drain passage, and cause water to leak from the indoor unit. Consult your dealer for inspection and maintenance, which require specialized knowledge and skills.	
		Do not operate switches with wet hands. • This may cause electric shock.
		Do not clean the air conditioner with water or place an object that contains water, such as a flower vase, on it. • This may cause fire or electric shock.
		Do not step on or place any object on the outdoor unit. • This may cause injury if you or the object falls down.

 IMPORTANT	
Dirty filters cause condensation in the air conditioner which will contribute to the growth of fungi such as mold. It is therefore recommended to clean air filters every 2 weeks.	
Before starting the operation, ensure that the horizontal vanes are in the closed position. If operation starts when the horizontal vanes are in the open position, they may not return to the correct position.	

For installation

 WARNING	
	Consult your dealer for installing the air conditioner. • It should not be installed by the user since installation requires specialized knowledge and skills. An improperly installed air conditioner may cause water leakage, fire, or electric shock.
	Provide a dedicated power supply for the air conditioner. • A non-dedicated power supply may cause overheating or fire.
	Do not install the unit where flammable gas could leak. • If gas leaks and accumulates around the outdoor unit, it may cause an explosion.
	Ground the unit correctly. • Do not connect the ground wire to a gas pipe, water pipe, lightning rod, or a telephone ground wire. Improper grounding may cause electric shock.
 CAUTION	
	Install a Ground Fault Interrupt (GFI) circuit breaker depending on the installation location of the air conditioner (such as highly humid areas). • If the Ground Fault Interrupt (GFI) breaker is not installed, it may cause electric shock.
	Ensure that the drain water is properly drained. • If the drain passage is improper, water may drip down from the indoor/outdoor unit, wetting and damaging the furniture.
In case of an abnormal condition Immediately stop operating the air conditioner and consult your dealer.	

NAME OF EACH PART

Indoor unit

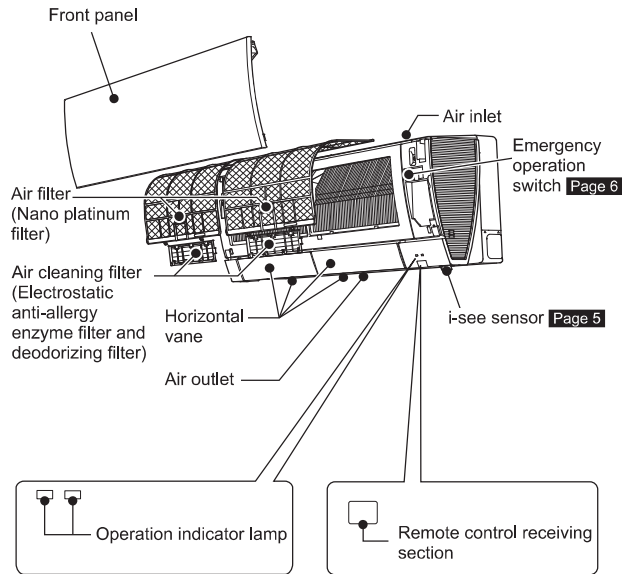

Outdoor unit

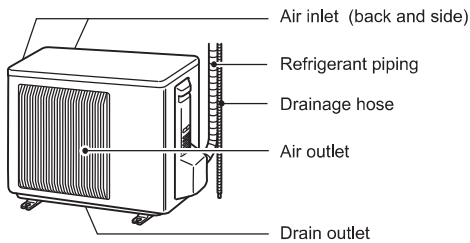

Outdoor units may be different in appearance.

Remote controller

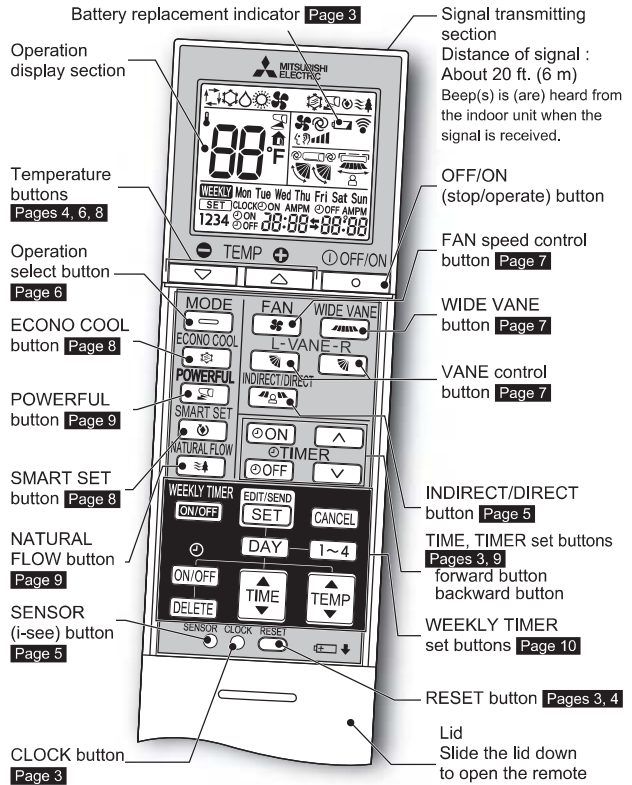

Remote controller holder

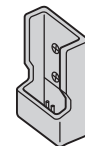

- Install the remote controller holder in a place where the signal can be received by the indoor unit.
- When the remote controller is not used, place it in this holder.

Only use the remote controller provided with the unit. Do not use other remote controllers. If two or more indoor units are installed in proximity to one another, an indoor unit that is not intended to be operated may respond to the remote controller.

PREPARATION BEFORE OPERATION

Before operation: Insert the power supply plug into the power outlet and/or turn the breaker on.

Installing the remote controller batteries

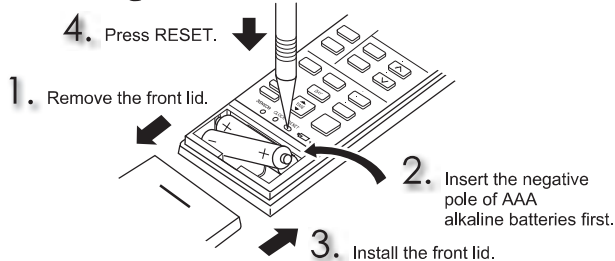

- Make sure the polarity of the batteries is correct.
- Do not use manganese batteries and leaking batteries. The remote controller could malfunction.
- Do not use rechargeable batteries.
- The battery replacement indicator lights up when the battery is running low. In about 7 days after the indicator starts lights up, the remote controller stops working.
- Replace all batteries with new ones of the same type.
- Batteries can be used for approximately 1 year. However, batteries with expired shelf lives last shorter.
- Press RESET gently using a thin instrument. If the RESET button is not pressed, the remote controller may not operate correctly.

Setting current time

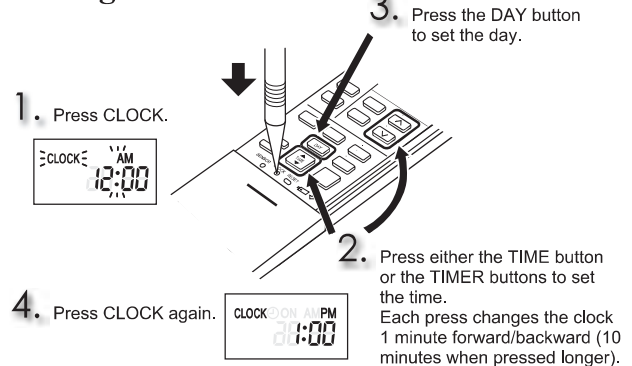

- Press CLOCK gently using a thin instrument.

PREPARATION BEFORE OPERATION

Changing temperature units (°F→°C)

Unit is preset with °F.

1. Press RESET while the temperature buttons are pressed.

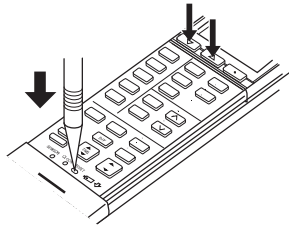

- Press RESET gently using a thin instrument.
- To change temperature unit from °C to °F, press RESET.

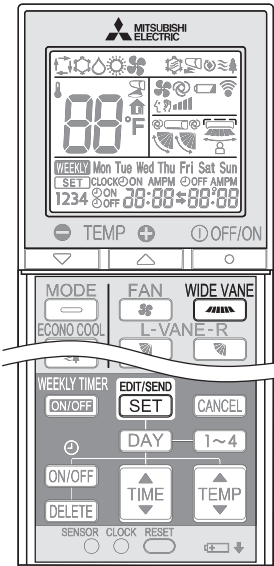

Setting the installation position

Be sure to set the remote controller in accordance with the installed position of the indoor unit.

Installation position:

- Left: Distance to objects (wall, cabinet, etc.) is less than 19-11/16 in. (50 cm) to the left
- Center: Distance to objects (wall, cabinet, etc.) is more than 19-11/16 in. (50 cm) to the left and right
- Right: Distance to objects (wall, cabinet, etc.) is less than 19-11/16 in. (50 cm) to the right

(Left) (Center) (Right)

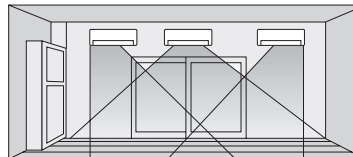

Area	Left	Center	Right
Remote controller display			

1. Hold down **WIDE VANE** on the remote controller for 2 seconds to enter the position setting mode.

2. Select the target installation position by pressing **WIDE VANE**.
(Each press of the **WIDE VANE** displays the positions in order:)



3. Press **EDIT/SEND SET** to complete the position setting.

Note:

The installation position can be set only when all the following conditions are met:

- The remote controller is powered off.
- Weekly timer is not set.
- Weekly timer is not being edited.

I-SEE OPERATION

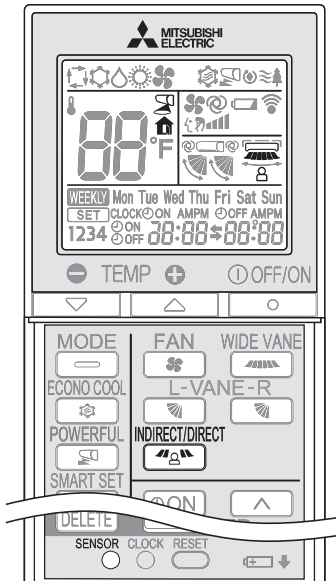

i-see control mode

In the i-see control mode, the room temperature is controlled based on the sensible temperature.

1 Press  during COOL, DRY, HEAT and AUTO mode to activate the i-see control mode.

- Press gently using a thin instrument.
-  lights. (Operation display section)
- The default setting is "active".

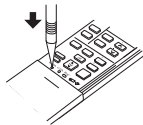

2 Press  again to activate ABSENCE DETECTION.

-  lights. (Operation display section)

3 Press  again to release the i-see control mode.

Note:

Any person at the following places cannot be detected:



- Along the wall on which the air conditioner is installed
- Directly under the air conditioner
- Where any obstacle, such as furniture, is between the person and the air conditioner

A person may not be detected in the following situations:

- Room temperature is high.
- A person wears heavy clothes and his/her skin is not exposed.
- A heating element of which temperature changes significantly is present.
- Some heat sources, such as a small child or pet, may not be sensed.
- A heat source and the air conditioner are more than 20 ft. (6 m) apart.
- A heat source does not move for a long time.

ABSENCE DETECTION

This function automatically changes the operation to energy-saving operation when nobody is in the room.

1 To activate this function, press  until  appears on the operation display of the remote controller.

2 Press  again to release ABSENCE DETECTION.



INDIRECT/DIRECT mode

The INDIRECT/DIRECT mode offers finely-tuned operation by locating where an occupant is in the room.

1 Press  during COOL, DRY, HEAT or AUTO mode to activate the INDIRECT/DIRECT mode. This mode is only available when the i-see control mode is effective.

2 Each press of  changes INDIRECT/DIRECT in the following order:



-  (INDIRECT): An occupant will be less exposed to direct airflow.
-  (DIRECT) : Mainly the vicinity of an occupant will be air-conditioned.

- Horizontal and vertical airflow directions will be automatically selected.
- When more than a couple of people are in a room, the INDIRECT/DIRECT mode may work less effectively.
- If you still feel uncomfortable with the air direction determined by the INDIRECT mode, adjust the air direction manually. [Page 7](#)

3 Canceling the i-see control mode automatically cancels the INDIRECT/DIRECT mode.

- The INDIRECT/DIRECT mode is also cancelled when the VANE or WIDE VANE buttons is pressed.

Note:

- Do not touch the i-see sensor. This may cause malfunction of the i-see sensor.
- The intermittent operating sound is a normal sound produced when the i-see sensor is moving from side to side.

SELECTING OPERATION MODES

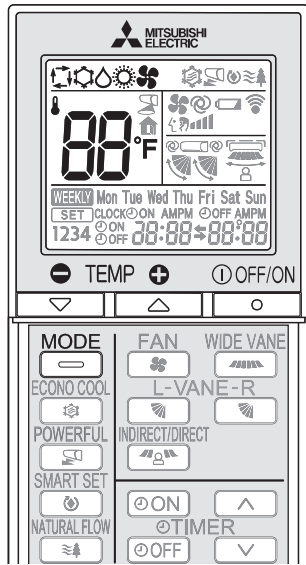

1 Press to start the operation.

2 Press to select operation mode. Each press changes mode in the following order:

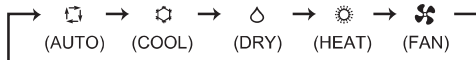

3 Press or to set the temperature. Each press raises or lowers the temperature by 1°F (0.5°C).

Press to stop the operation.

Note:

Multi system operation

Two or more indoor units can be operated by one outdoor unit. When several indoor units are operated simultaneously, cooling/dry/fan and heating operations cannot be done at the same time. When COOL/DRY/FAN is selected with one unit and HEAT with another or vice versa, the unit selected last goes into standby mode.

Operation indicator lamp

The operation indicator lamp shows the operation state of the unit.

Indication	Operation state	Room temperature
	The unit is operating to reach the set temperature	About 4°F (2°C) or more away from set temperature
	The room temperature is approaching the set temperature	About 2 to 4°F (1 to 2°C) from set temperature
	Standby mode (only during multi system operation)	—

Lighted Blinking Not lighted

AUTO mode (Auto change over)

The unit selects the operation mode according to the difference between the room temperature and the set temperature. During AUTO mode, the unit changes mode (COOL→HEAT) when the room temperature is about 4°F (2°C) away from the set temperature for more than 15 minutes.

Note:

Auto Mode is not recommended if this indoor unit is connected to a MXZ type outdoor unit. When several indoor units are operated simultaneously, the unit may not be able to switch operation mode between COOL and HEAT. In this case, the indoor unit becomes standby mode (Refer to table of Operation indicator lamp).

COOL mode

Enjoy cool air at your desired temperature.

Note:

Do not operate COOL mode at very low outside temperatures (less than 14°F [-10°C]). Water condensed in the unit may drip and wet or damage furniture, etc.

DRY mode

Dehumidify your room. The room may be cooled slightly. Temperature cannot be set during DRY mode.

HEAT mode

Enjoy warm air at your desired temperature.

FAN mode

Circulate the air in your room.

Note:

After COOL/DRY mode operation, it is recommended to operate in the FAN mode to dry inside the indoor unit.

Emergency operation

When the remote controller cannot be used...

Emergency operation can be activated by pressing the emergency operation switch (E.O.SW) on the indoor unit.

Each time the E.O.SW is pressed, the operation changes in the following order:

Operation indicator lamp

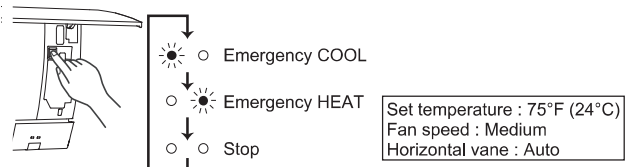

Note:

- The first 30 minutes of operation is test run. Temperature control does not work, and fan speed is set to High.
- In the emergency heating operation, the fan speed gradually rises to blow out warm air.
- In the emergency cooling operation, the horizontal vanes' position will be reset in about a minute, then the operation will start.

Auto restart function



If a power failure occurs or the main power is turned off during operation, "Auto restart function" automatically starts operation in the same mode as the one set with the remote controller just before the shutoff of the main power. When timer is set, timer setting is cancelled and the unit starts operation when power is resumed.

If you do not want to use this function, please consult the service representative because the setting of the unit needs to be changed.

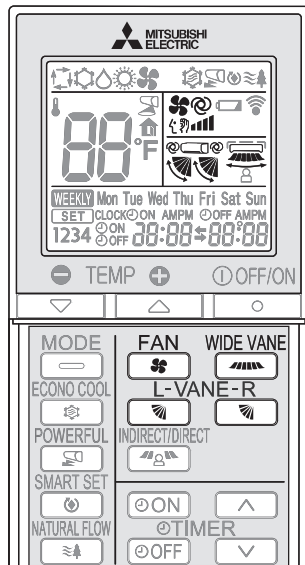
FAN SPEED AND AIRFLOW DIRECTION ADJUSTMENT



Airflow direction

-  (AUTO)The vane is set to the most efficient airflow direction. COOL/ DRY/FAN:horizontal position. HEAT:position (4).
-  (Manual)For efficient air conditioning, select the upper position for COOL/DRY, and the lower position for HEAT. If the lower position is selected during COOL/DRY, the vane automatically moves to the upward position (3) after 0.5 to 1 hour to prevent any condensation from dripping.
-  (Swing)The vane moves up and down intermittently.

Press  to select fan speed. Each press changes fan speed in the following order:

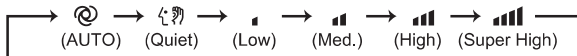

- Two short beeps are heard from the indoor unit when set to AUTO.
- Use higher fan speed to cool/heat the room quicker. It is recommended to lower the fan speed once the room is cool/warm.
- Use lower fan speed for quiet operation.

Note:

Multi system operation

When several indoor units are operated simultaneously by one outdoor unit for heating operation, the temperature of the airflow may be low. In this case, it is recommended to set the fan speed to AUTO.

Press  to select airflow direction. Each press changes airflow direction in the following order:

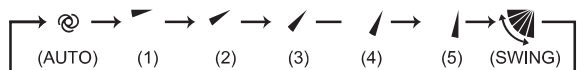

- Two short beeps are heard from the indoor unit when set to AUTO.
- Always use the remote controller when changing the direction of airflow. Moving the horizontal vanes with your hands causes them to malfunction.
- When the breaker is turned on, the horizontal vanes' position will be reset in about a minute, then the operation will start. The same is true in the emergency cooling operation.
- When the horizontal vanes seem to be in an abnormal position, see [page 12](#).
- The right and left horizontal vanes set to the same level may not align perfectly.

Press  to select horizontal airflow direction. Each press changes airflow direction in the following order:



SMART SET OPERATION

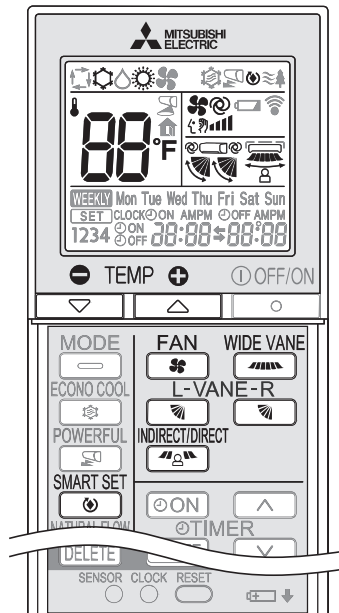

1 Press  during COOL, or HEAT mode to select SMART SET mode.

2 Set the temperature, fan speed, and airflow direction.

- The same setting is selected from the next time by simply pressing .
- Two settings can be saved. (One for COOL, one for HEAT)
- Select the appropriate temperature, fan speed, and airflow direction according to your room.
- Normally, the minimum temperature setting in HEAT mode is 61°F (16°C). However, during SMART SET operation only, the minimum temperature setting is 50°F (10°C).

Press  again to cancel SMART SET operation.

- SMART SET operation also is cancelled when the MODE button is pressed.

SMART SET operation

- A simplified set back function enables to recall the preferred (preset) setting with a single push of the  button. Press the button again and you can go back to the previous setting in an instance.
- SMART SET operation cannot be set on the weekly timer.

Example of use:

- Low energy mode
Set the temperature 4°F (2°C) to 6°F (3°C) warmer in COOL and cooler in HEAT mode. This setting is suitable for unoccupied room, and while you are sleeping.
- Saving frequently used settings
Save your preferred setting for COOL and HEAT. This enables you to select your preferred setting with a single push of the button.

ECONO COOL OPERATION

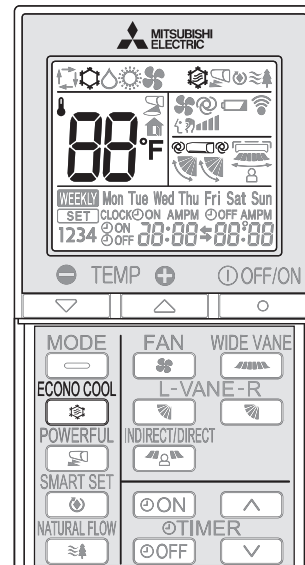

Press  during COOL mode **page 6** to start ECONO COOL operation.

The unit performs swing operation vertically in various cycles according to the temperature airflow.

Press  again to cancel ECONO COOL operation.

- ECONO COOL operation is also cancelled when the VANE, POWERFUL, or NATURAL FLOW button is pressed.

What is "ECONO COOL"?

Swing airflow (change of air flow) makes you feel cooler than stationary airflow. The set temperature and the airflow direction are automatically changed by the microprocessor. It is possible to perform cooling operation with keeping comfort. As a result energy can be saved.

NATURAL FLOW OPERATION

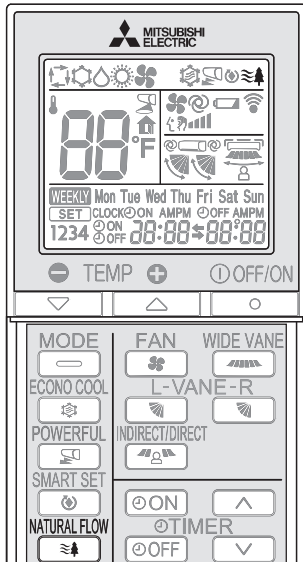

Press  during COOL or FAN mode [page 6](#) to start NATURAL FLOW operation.

Press  again to cancel NATURAL FLOW operation.

- NATURAL FLOW operation is also canceled when the POWERFUL or ECONO COOL button is pressed.

What is "NATURAL FLOW"?

Airflow that imitates a natural breeze is produced in this mode. The discomfort of being hit directly by constant, unnatural airflow will be reduced.

Note:

As the fan speed changes constantly during NATURAL FLOW operation, the sound of air flow, wind velocity and air flow temperature also change. This is not a malfunction.

POWERFUL OPERATION

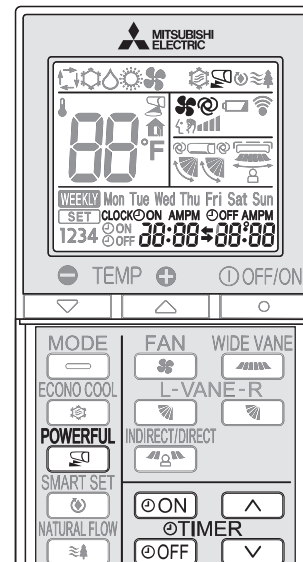

Press  during COOL or HEAT mode [page 6](#) to start POWERFUL operation.

Fan speed : Exclusive speed for POWERFUL mode
Horizontal vane : Set position, or downward airflow position during AUTO setting

- Temperature cannot be set during POWERFUL operation.

Press  again to cancel POWERFUL operation.

- POWERFUL operation is also cancelled automatically in 15 minutes, or when the ON/OFF, FAN, ECONO COOL, NATURAL FLOW, or i-save button is pressed.

TIMER OPERATION (ON/OFF TIMER)



1 Press  or  during operation to set the timer.

 (ON timer) : The unit turns ON at the set time.



 (OFF timer) : The unit turns OFF at the set time.

*  or  blinks.

* Make sure that the current time and day are set correctly. [Page 3](#)

2 Press  (forward) and  (backward) to set the time of timer.

Each press changes the set time 10 minutes forward/backward.

- Set the timer while  or  is blinking.

3 Press  or  again to cancel timer.

Note:

- ON and OFF timers can be set together.  mark indicates the order of timer operations.
- If power failure occurs while ON/OFF timer is set, see [page 6](#) "Auto restart function".

WEEKLY TIMER OPERATION

- A maximum of 4 ON or OFF timers can be set for individual days of the week.
- A maximum of 28 ON or OFF timers can be set for a week.

E.g. : Runs at 75°F (24°C) from waking up to leaving home, and runs at 81°F (27°C) from getting home to going to bed on weekdays.
Runs at 81°F (27°C) from waking up late to going to bed early on weekends.

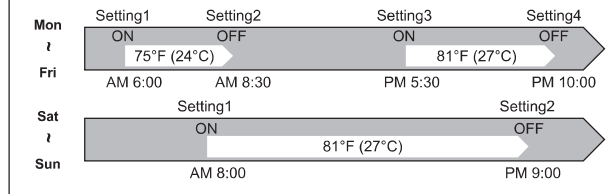

Note:

The simple ON/OFF timer setting is available while the weekly timer is on. In this case, the ON/OFF timer has priority over the weekly timer; the weekly timer operation will start again after the simple ON/OFF timer is complete.

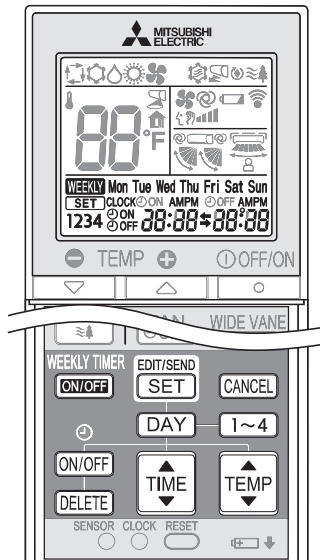

Setting the weekly timer

* Make sure that the current time and day are set correctly.

1 Press **EDIT/SEND SET** to enter the weekly timer setting mode.

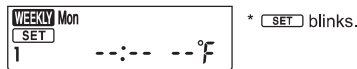

2 Press **DAY** and **1~4** to select setting day and number.

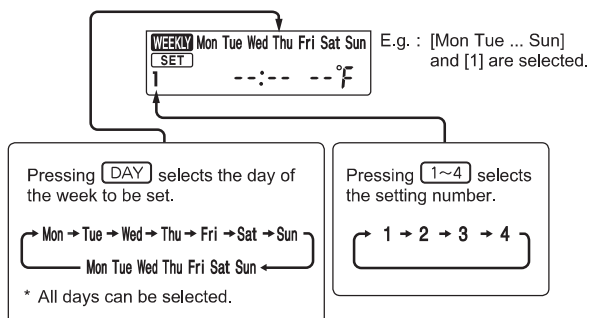

3 Press **ON/OFF**, **TIME**, and **TEMP** to set ON/OFF, time, and temperature.

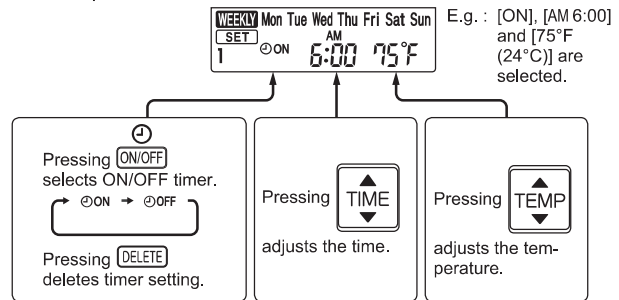

- * Hold down the button to change the time quickly.
- * The temperature can be set between 61°F and 88°F (16°C and 31°C) at weekly timer.

Press **DAY** and **1~4** to continue setting the timer for other days and/or numbers.

4 Press **EDIT/SEND SET** to complete and transmit the weekly timer setting.



Note:

- Press **EDIT/SEND SET** to transmit the setting information of weekly timer to the indoor unit. Point the remote controller toward the indoor unit for 3 seconds.
- When setting the timer for more than one day of the week or one number, **EDIT/SEND SET** does not have to be pressed per each setting. Press **EDIT/SEND SET** once after all the settings are complete. All the weekly timer settings will be saved.
- Press **EDIT/SEND SET** to enter the weekly timer setting mode, and press and hold **DELETE** for 5 seconds to erase all weekly timer settings. Point the remote controller toward the indoor unit.

5 Press **WEEKLY TIMER ON/OFF** to turn the weekly timer ON. (**WEEKLY** lights.)

* When the weekly timer is ON, the day of the week whose timer setting is complete, will light.

Press **WEEKLY TIMER ON/OFF** again to turn the weekly timer OFF. (**WEEKLY** goes out.)

Note:

The saved settings will not be cleared when the weekly timer is turned OFF.

Checking weekly timer setting

1 Press **EDIT/SEND SET** to enter the weekly timer setting mode.

* **SET** blinks.

2 Press **DAY** or **1~4** to view the setting of the particular day or number.

Press **CANCEL** to exit the weekly timer setting.

Note:

When all days of the week are selected to view the settings and a different setting is included among them, **---:-- --°F** will be displayed.

CLEANING

Instructions:

- Switch off the power supply or turn off the breaker before cleaning.
- Be careful not to touch the metal parts with your hands.
- Do not use benzine, thinner, polishing powder, or insecticide.
- Use only diluted mild detergents.
- Do not expose parts to direct sunlight, heat, or fire to dry.
- Do not use water hotter than 122°F (50°C).

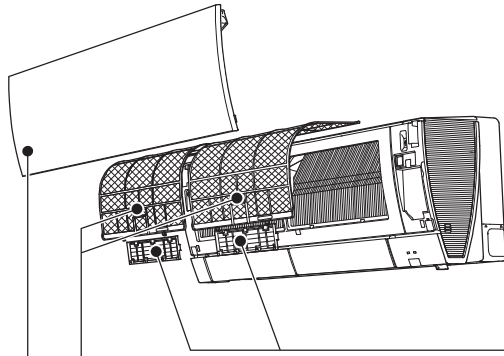

Air filter (Nano platinum filter)

- **Clean every 2 weeks**
- Remove dirt by a vacuum cleaner, or rinse with water.
- After washing with water, dry it well in shade.

What is “Nano platinum filter”?

Nano platinum is a ceramic particle that includes a platinum nanoparticle. The particles are incorporated into the filter material, which results in providing semi-permanent antibacterial and deodorizing characteristics for the filter. Nano platinum surpasses the catechin (a bioflavonoid that is found in green tea) in performance. Nano platinum filter uses this compound not only to improve air quality but also to eliminate bacteria and viruses. This air filter has a semi-permanent lasting effect even after washing it with water.

Front panel

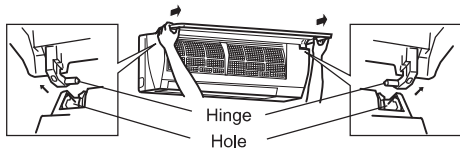

1. Lift the front panel until a “click” is heard.
2. Hold the hinges and pull to remove as shown in the illustration above.
 - Wipe with a soft dry cloth or rinse it with water.
 - Do not soak it in water for more than two hours.
 - Dry it well in shade.
3. Install the front panel by following the removal procedure in reverse. Close the front panel securely and press the positions indicated by the arrows.



Air cleaning filter (Electrostatic anti-allergy enzyme filter, blue)

- **Every 3 months:**
 - Remove dirt by a vacuum cleaner.
- **When dirt cannot be removed by vacuum cleaning:**
 - Soak the filter and its frame in lukewarm water before rinsing it.
 - After washing, dry it well in shade. Install all tabs of the air filter.

- **Every year:**
 - Replace it with a new air cleaning filter for best performance.
 - Parts Number **MAC-2330FT-E**

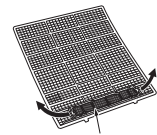

Pull to remove from the air filter

and

(Deodorizing filter, black)

- **Every 3 months:**
 - Remove dirt by a vacuum cleaner, or soak the framed filter in lukewarm water 86 to 104°F [30 to 40°C] for about 15 minutes. Rinse well.
 - After washing, dry it well in shade.
 - Deodorizing feature recovers by cleaning the filter.

- **When dirt or smell cannot be removed by cleaning:**
 - Replace it with a new air cleaning filter.
 - Parts Number **MAC-3000FT-E**

! Important

- **Clean the filters regularly for best performance and to reduce power consumption.**
- **Dirty filters cause condensation in the air conditioner which will contribute to the growth of fungi such as mold. It is therefore recommended to clean air filters every 2 weeks.**

WHEN YOU THINK THAT TROUBLE HAS OCCURRED

Even if these items are checked, when the unit does not recover from the trouble, stop using the air conditioner and consult your dealer.

Symptom	Explanation & Check points
Indoor Unit	
The unit cannot be operated.	<ul style="list-style-type: none"> Is the breaker turned on? Is the power supply plug connected? Is the ON timer set? Page 9
The horizontal vane does not move.	<ul style="list-style-type: none"> Are the horizontal vane and the vertical vane installed correctly? Is the fan guard deformed? When the breaker is turned on, the horizontal vanes' position will be reset in about a minute. After the reset has completed, the normal horizontal vanes' operation resumes. The same is true in the emergency cooling operation.
The unit cannot be operated for about 3 minutes when restarted.	<ul style="list-style-type: none"> This protects the unit according to instructions from the microprocessor. Please wait.
Mist is discharged from the air outlet of the indoor unit.	<ul style="list-style-type: none"> The cool air from the unit rapidly cools moisture in the air inside the room, and it turns into mist.
The swing operation of the HORIZONTAL VANE is suspended for a while, then restarted.	<ul style="list-style-type: none"> This is for the swing operation of the HORIZONTAL VANE to be performed normally.
When SWING is selected in COOL/DRY/FAN mode, the lower horizontal vane does not move.	<ul style="list-style-type: none"> It is normal that the lower horizontal vane does not move when SWING is selected in COOL/DRY/FAN mode.
The airflow direction changes during operation. The direction of the horizontal vane cannot be adjusted with the remote controller.	<ul style="list-style-type: none"> When the unit is operated in COOL or DRY mode, if the operation continues with air blowing down for 0.5 to 1 hour, the direction of the airflow is automatically set to upward position to prevent water from condensing and dripping. In the heating operation, if the airflow temperature is too low or when defrosting is being done, the horizontal vane is automatically set to horizontal position.
The operation stops for about 10 minutes in the heating operation.	<ul style="list-style-type: none"> Outdoor unit is in defrost. Since this is completed in max. 10 minutes, please wait. (When the outside temperature is too low and humidity is too high, frost is formed.)
The unit starts operation by itself when the main power is turned on, but hasn't received sign from the remote controller.	<ul style="list-style-type: none"> These models are equipped with an auto restart function. When the main power is turned off without stopping the unit with the remote controller and is turned on again, the unit starts operation automatically in the same mode as the one set with the remote controller just before the shutoff of the main power. Refer to "Auto restart function" page 6.
The two horizontal vanes touch each other. The horizontal vanes are in an abnormal position. The horizontal vanes do not return to the correct "close position".	Perform one of the following: <ul style="list-style-type: none"> Turn off and on the breaker. Make sure the horizontal vanes move to the correct "close position". Start and stop the emergency cooling operation and make sure the horizontal vanes move to the correct "close position".
The indoor unit discolors over time.	<ul style="list-style-type: none"> Although plastic turns yellow due to the influence of some factors such as ultraviolet light and temperature, this has no effect on the product functions.
Multi system	
The indoor unit which is not operating becomes warm and a sound, similar to water flowing, is heard from the unit.	<ul style="list-style-type: none"> A small amount of refrigerant continues to flow into the indoor unit even though it is not operating.
When heating operation is selected, operation does not start right away.	<ul style="list-style-type: none"> When operation is started during defrosting of outdoor unit is done, it takes a few minutes (max. 10 minutes) to blow out warm air.
Outdoor Unit	
The fan of the outdoor unit does not rotate even though the compressor is running. Even if the fan starts to rotate, it stops soon.	<ul style="list-style-type: none"> When the outside temperature is low during cooling operation, the fan operates intermittently to maintain sufficient cooling capacity.
Water leaks from the outdoor unit.	<ul style="list-style-type: none"> During COOL and DRY operations, pipe or pipe connecting sections are cooled and this causes water to condense. In the heating operation, water condensed on the heat exchanger drips down. In the heating operation, the defrosting operation makes ice forming on the outdoor unit melt and drip down.
White smoke is discharged from the outdoor unit.	<ul style="list-style-type: none"> In the heating operation, vapor generated by the defrosting operation looks like white smoke.

Symptom	Explanation & Check points
Remote controller	
The display on the remote controller does not appear or it is dim. The indoor unit does not respond to the remote control signal.	<ul style="list-style-type: none"> Are the batteries exhausted? Page 3 Is the polarity (+, -) of the batteries correct? Page 3 Are any buttons on the remote controller of other electric appliances being pressed?
Does not cool or heat	
The room cannot be cooled or heated sufficiently.	<ul style="list-style-type: none"> Is the temperature setting appropriate? Page 6 Is the fan setting appropriate? Please change fan speed to High or Super High. Page 7 Are the filters clean? Page 11 Is the fan or heat exchanger of the indoor unit clean? Are there any obstacles blocking the air inlet or outlet of the indoor or outdoor unit? Is a window or door open? It may take a certain time to reach the setting temperature or may not reach that depending on the size of the room, the ambient temperature, and the like.
The room cannot be cooled sufficiently.	<ul style="list-style-type: none"> When a ventilation fan or a gas cooker is used in a room, the cooling load increases, resulting in an insufficient cooling effect. When the outside temperature is high, the cooling effect may not be sufficient.
The room cannot be heated sufficiently.	<ul style="list-style-type: none"> When the outside temperature is low, the heating effect may not be sufficient.
Air does not blow out soon in the heating operation.	<ul style="list-style-type: none"> Please wait as the unit is preparing to blow out warm air.
Airflow	
The air from the indoor unit smells strange.	<ul style="list-style-type: none"> Are the filters clean? Page 11 Is the fan or heat exchanger of the indoor unit clean? The unit may suck in an odor adhering to the wall, carpet, furniture, cloth, etc. and blow it out with the air.
Sound	
Cracking sound is heard.	<ul style="list-style-type: none"> This sound is generated by the expansion/contraction of the front panel, etc. due to change in temperature.
"Bubbling" sound is heard.	<ul style="list-style-type: none"> This sound is heard when the outside air is absorbed from the drain hose by turning on the range hood or the ventilation fan, making water flowing in the drain hose to spout out. This sound is also heard when the outside air blows into the drain hose in case the outside wind is strong.
Mechanical sound is heard from the indoor unit.	<ul style="list-style-type: none"> This is the switching sound in turning on/off the fan or the compressor.
The sound of water flowing is heard.	<ul style="list-style-type: none"> This is the sound of refrigerant or condensed water flowing in the unit.
Hissing sound is sometimes heard.	<ul style="list-style-type: none"> This is the sound when the flow of refrigerant inside the unit is changed.
Timer	
Weekly timer does not operate according to settings.	<ul style="list-style-type: none"> Is the ON/OFF timer set? Pages 9, 10 Transmit the setting information of the weekly timer to the indoor unit again. When the information is successfully received, a long beep will sound from the indoor unit. If information fails to be received, 3 short beeps will be heard. Ensure information is successfully received. Page 10 When a power failure occurs and the main power turns off, the indoor unit built-in clock will be incorrect. As a result, the weekly timer may not work normally. Be sure to place the remote controller where the signal can be received by the indoor unit. Page 3
The unit starts/stops the operation by itself.	<ul style="list-style-type: none"> Is the weekly timer set? Page 10

In the following cases, stop using the air conditioner and consult your dealer.

- When water leaks or drips from the indoor unit.
- When the operation indicator lamp blinks. Except for when the lamp of a multi unit blinks while the unit is on standby.
- When the breaker trips frequently.
- The remote control signal is not received in a room where an electronic ON/OFF type fluorescent lamp (inverter-type fluorescent lamp, etc.) is used.
- Operation of the air conditioner interferes with radio or TV reception. An amplifier may be required for the affected device.
- When an abnormal sound is heard.
- When any refrigerant leakage is found.

WHEN THE AIR CONDITIONER IS NOT GOING TO BE USED FOR A LONG TIME

- 1 Set to the highest temperature in manual COOL mode, and operate for 3 to 4 hours. **Page 6**
 - This dries the inside of the unit.
 - Moisture in the air conditioner contributes to favorable conditions for growth of fungi, such as mold.
- 2 Press  to stop the operation.
- 3 Turn off the breaker and/or disconnect the power supply plug.
- 4 Remove all batteries from the remote controller.

When using the air conditioner again:

- 1 Clean the air filter. **Page 11**
- 2 Check that the air inlet and outlet of the indoor and outdoor units are not blocked.
- 3 Check that the ground is connected correctly.
- 4 Refer to the "PREPARATION BEFORE OPERATION", and follow the instructions. **Page 3**

INSTALLATION PLACE AND ELECTRICAL WORK

Installation place

Avoid installing the air conditioner in the following places.

- Where there is much machine oil.
- Salty places such as the seaside.
- Where sulfide gas is generated such as hot spring, sewage, waste water.
- Where oil is splashed or where the area is filled with oily smoke (such as cooking areas and factories, in which the properties of plastic could be changed and damaged).
- Where there is high-frequency or wireless equipment.
- Where the air from the outdoor unit air outlet is blocked.
- Where the operation sound or air from the outdoor unit bothers the house next door.
- The mounting height of indoor unit 5.9 ft. to 7.5 ft. (1.8 m to 2.3 m) is recommended. If it is impossible, please consult your dealer.

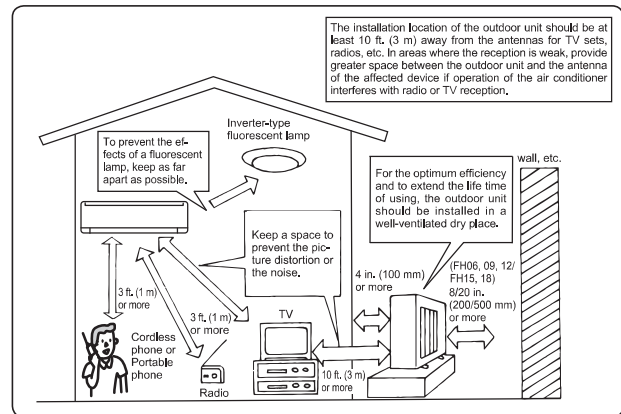

Electrical work

- Provide an exclusive circuit for the power supply of the air conditioner.
- Be sure to observe the breaker capacity.

If you have any questions, consult your dealer.

SPECIFICATIONS

Guaranteed operating range

		Indoor	Outdoor
Cooling	Upper limit	90°F (32.2°C) DB 73°F (22.8°C) WB	115°F (46.1°C) DB —
	Lower limit	67°F (19.4°C) DB 57°F (13.9°C) WB	14°F (-10°C) DB —
Heating	Upper limit	80°F (26.7°C) DB —	75°F (23.9°C) DB 65°F (18.3°C) WB
	Lower limit	70°F (21.1°C) DB —	-13°F (-25°C) DB -14°F (-25.6°C) WB

DB: Dry Bulb
WB: Wet Bulb

Note:

1. The guaranteed operating range value is for 1:1 System Application.
2. If the outdoor temperature is below the lower limit of guaranteed operating range, the outdoor unit may stop operation until the outdoor temperature exceeds the lower limit.